

NP12-4.5Ah 12V4.5Ah

Specifications

Nominal Voltage		12V
Rated capacity (20 hour rate)		4.5Ah
Dimensions	Length	90±1mm(3.54inch)
	Width	70±1mm(2.76inch)
	Height	101±1mm(3.98inch)
	Total Height	106±1mm(4.17inch)
Approx. Weight		1.53kg(3.37lbs)±4%



Outer dimensions (mm)

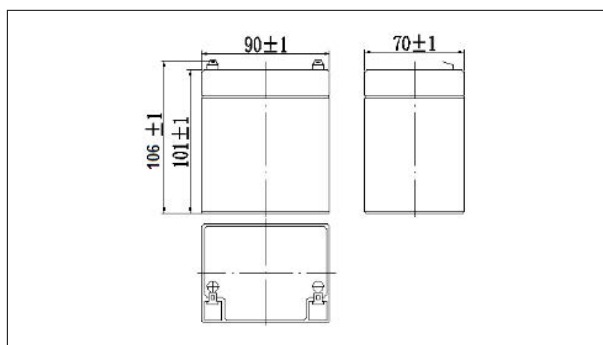

Terminal Type (mm)

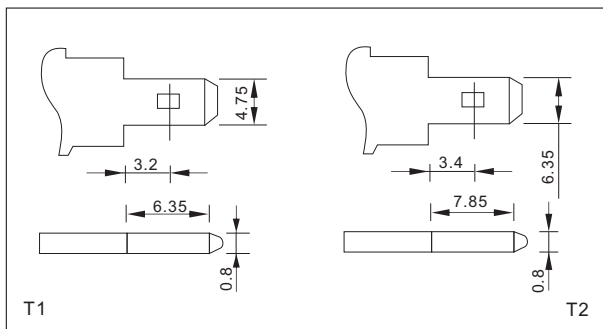

Characteristics

Capacity (25°C)	20HR(10.5V)	4.5Ah
	10HR(10.5V)	4.2Ah
	1HR(9.60V)	2.7Ah
Terminal type		T1/T2
Internal resistance (Fully charged,25°C)		Approx.30m Ω
Capacity affected by temperature (20HR)	40°C	102%
	25°C	100%
	0°C	85%
	-15°C	65%
Self-discharge (25°C)	3 months	Remaining Capacity:91%
	6 months	Remaining Capacity:82%
	12 months	Remaining Capacity:65%
Nominal operating temperature		25°C ±3°C(77°F ±5°F)
Operating temperature range	Discharge	-15°C~50°C(5°F~122°F)
	Charge	-10°C~50°C(14°F~122°F)
	Storage	-20°C~50°C(-4°F~122°F)
Float charging voltage(25°C)		13.50 to 13.80V Temperature compensation: -18mV/°C
Cyclic charging voltage(25°C)		14.50 to 15.00V Temperature compensation: -30mV/°C
Maximum charging current		1.35A
Maximum discharge current		68A(5 sec.)
Designed floating life(20°C)		5 years

Construction

Component	Positive plate	Negative plate	Container	Cover	Separator	Electrolyte	Safety valve	Terminal
Raw material	Lead dioxide	Lead	ABS	ABS	AGM	Sulfuric acid	Rubber	Copper

Constant Current Discharge Characteristics Unit:A(25°C,77°F)

F.V/Time	5min	10min	15min	30min	60min	2h	3h	4h	5h	10h	20h
9.60V	17.2	10.9	8.51	4.79	2.95	1.61	1.12	0.92	0.78	0.43	0.23
9.90V	16.7	10.6	8.30	4.70	2.90	1.60	1.11	0.92	0.78	0.42	0.23
10.2V	16.0	10.1	7.99	4.55	2.83	1.59	1.10	0.91	0.77	0.42	0.23
10.5V	15.3	9.69	7.72	4.44	2.77	1.56	1.09	0.90	0.77	0.42	0.23
10.8V	14.4	9.15	7.31	4.28	2.69	1.52	1.06	0.88	0.75	0.41	0.22

Constant Power Discharge Characteristics Unit:W(25°C,77°F)

F.V/Time	5min	10min	15min	30min	60min	2h	3h	4h	5h	10h	20h
9.60V	192	123	97.0	54.9	34.1	18.9	13.3	11.0	9.37	5.11	2.74
9.90V	186	119	94.6	53.8	33.6	18.8	13.2	10.9	9.32	5.09	2.73
10.2V	178	114	91.1	52.2	32.8	18.6	13.1	10.8	9.25	5.07	2.72
10.5V	171	109	88.0	50.9	32.1	18.3	13.0	10.8	9.19	5.04	2.70
10.8V	161	103	83.4	49.0	31.1	17.8	12.6	10.4	8.91	4.94	2.65

Note: The above characteristics data can be obtained within three charge or discharge cycles.

NP12-4.5Ah 12V4.5Ah

Discharge characteristics(25°C)

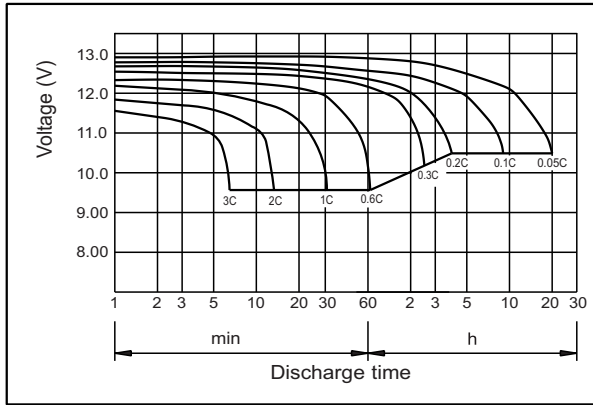

Charging characteristics (25°C)

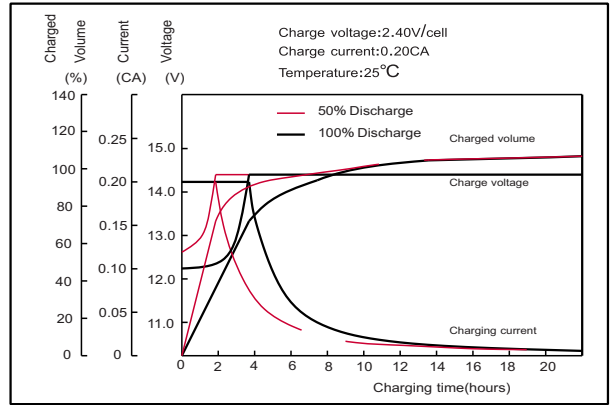

Effect of temperature on capacity

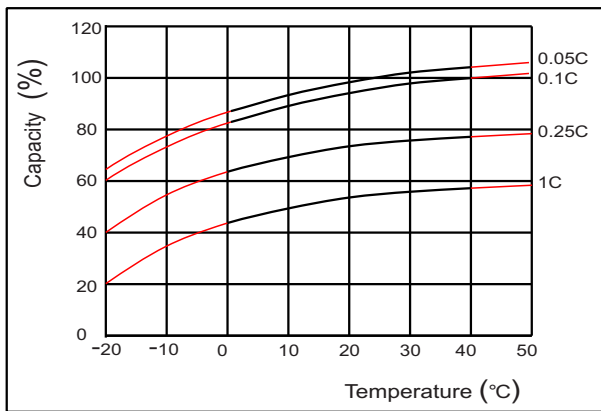

Self-discharge characteristics

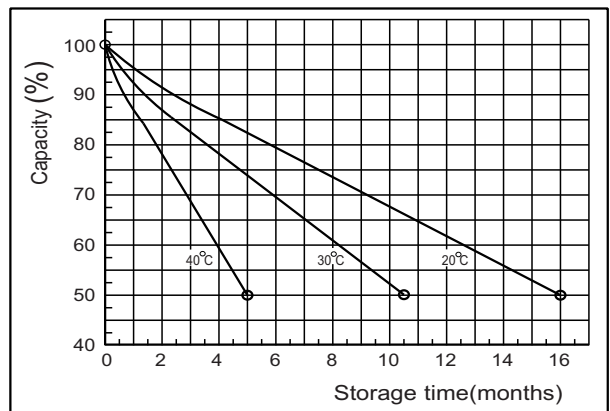

Floating life on temperature

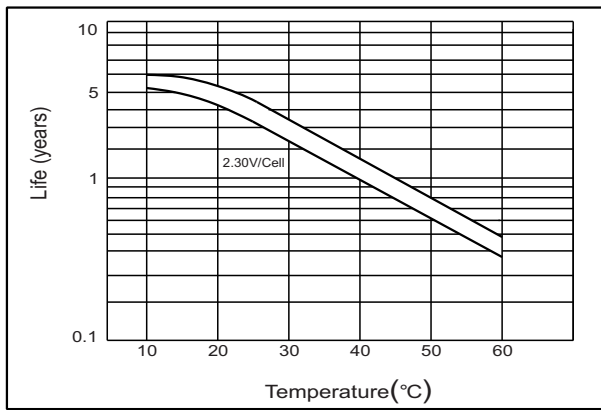

Cycle life on D.O.D(25°C)

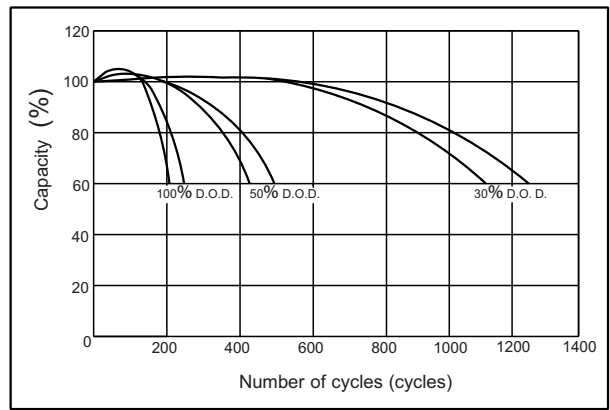

The relationship for OCV and Capacity (25°C)

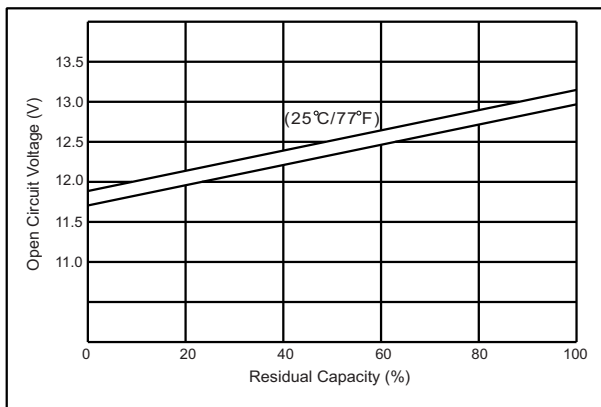

The relationship for Charging voltage and Temperature

