

## NPD12-80Ah 12V80Ah

### ● Specifications

Nominal Voltage		12V
Rated capacity (20 hour rate)		80Ah
Dimensions	Length	260±2mm(10.24inch)
	Width	168±2mm(6.61inch)
	Height	211±2mm(8.31inch)
	Total Height	215±2mm(8.46inch)
Approx. Weight		25.3kg(55.8lbs)±3%



### ● Outer dimensions (mm)

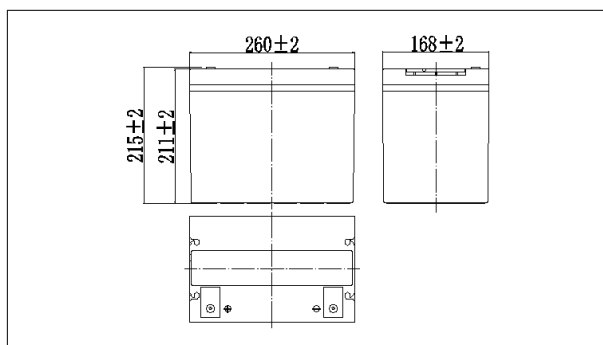

### ● Terminal Type (mm)

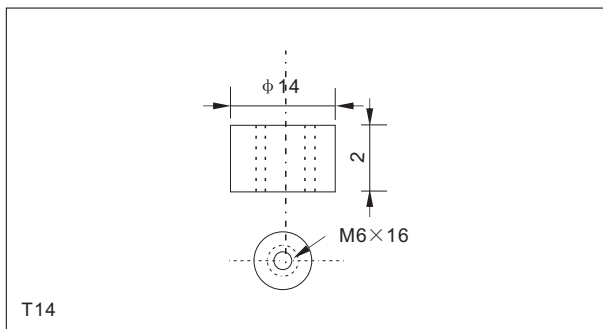

### ● Characteristics

Capacity (25°C)	20HR(10.8V)	80Ah
	3HR(10.8V)	61.5Ah
	1HR(10.5V)	46Ah
Terminal type		T14
Internal resistance (Fully charged, 25°C)		Approx. 5m Ω
Capacity affected by temperature (20HR)	40°C	102%
	25°C	100%
	0°C	85%
	-15°C	65%
Self-discharge (25°C)	3 months	Remaining Capacity:91%
	6 months	Remaining Capacity:82%
	12 months	Remaining Capacity:65%
Nominal operating temperature		25°C ±3°C(77°F ±5°F)
Operating temperature range	Discharge	-15°C~50°C(5°F~122°F)
	Charge	-10°C~50°C(14°F~122°F)
	Storage	-20°C~50°C(-4°F~122°F)
Float charging voltage(25°C)		13.50 to 13.80V Temperature compensation: -18mV/°C
Cyclic charging voltage(25°C)		14.50 to 15.00V Temperature compensation: -30mV/°C
Maximum charging current		24A
Maximum discharge current		700A(5 sec.)
Designed floating life(20°C)		10years

### ● Construction

Component	Positive plate	Negative plate	Container	Cover	Separator	Electrolyte	Safety valve	Terminal
Raw material	Lead dioxide	Lead	ABS	ABS	AGM	Sulfuric acid	Rubber	Copper

### ● Constant Current Discharge Characteristics Unit:A(25°C,77°F)

F.V/Time	10min	15min	30min	60min	2h	3h	4h	5h	8h	10h	20h
9.60V	179	138	82.4	50.7	30.0	21.6	17.2	14.7	10.1	8.35	4.42
9.90V	173	134	80.8	49.9	29.8	21.5	17.1	14.6	10.1	8.33	4.42
10.2V	166	129	78.3	48.6	29.5	21.3	17.0	14.5	9.99	8.31	4.40
10.5V	159	125	76.4	47.1	29.1	21.2	16.9	14.4	9.92	8.26	4.38
10.8V	150	118	73.6	45.6	28.3	20.5	16.4	14.0	9.62	8.20	4.35

### ● Constant Power Discharge Characteristics Unit:W(25°C,77°F)

F.V/Time	10min	15min	30min	60min	2h	3h	4h	5h	8h	10h	20h
9.60V	1931	1513	925	578	347	254	203	174	120	99.7	53.1
9.90V	1873	1476	906	569	345	252	201	173	120	99.5	53.0
10.2V	1795	1422	878	555	342	251	200	172	119	99.2	52.8
10.5V	1718	1373	857	537	337	249	199	171	118	98.6	52.5
10.8V	1622	1301	826	520	328	241	193	165	114	97.9	52.2

Note: The above characteristics data can be obtained within three charge or discharge cycles.

# NPD12-80Ah 12V80Ah

● **Discharge characteristics(25°C)**

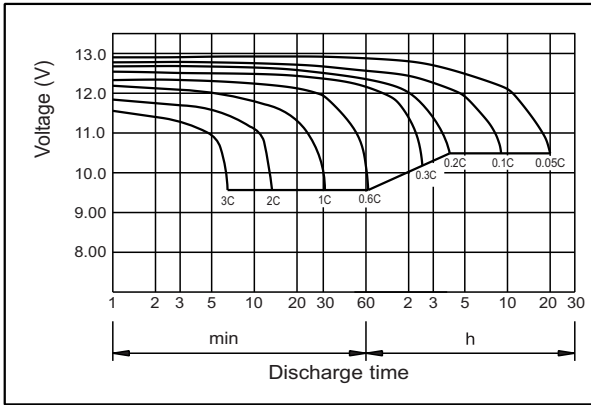

● **Charging characteristics (25°C)**

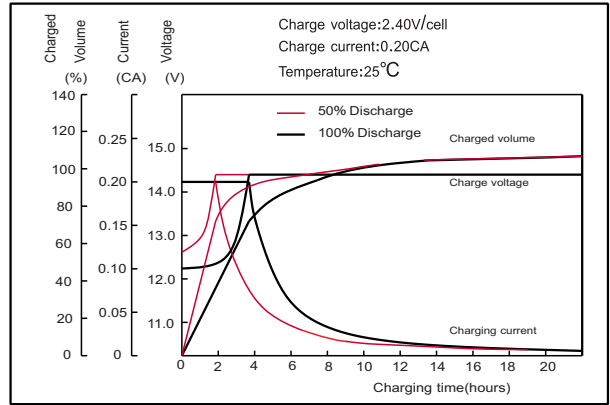

● **Temperature effects on Capacity**

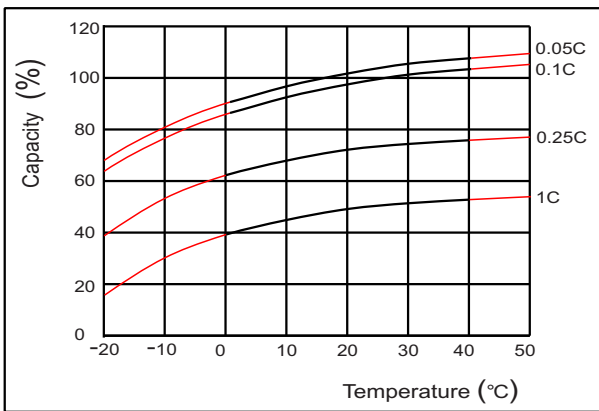

● **Self-discharge characteristics**

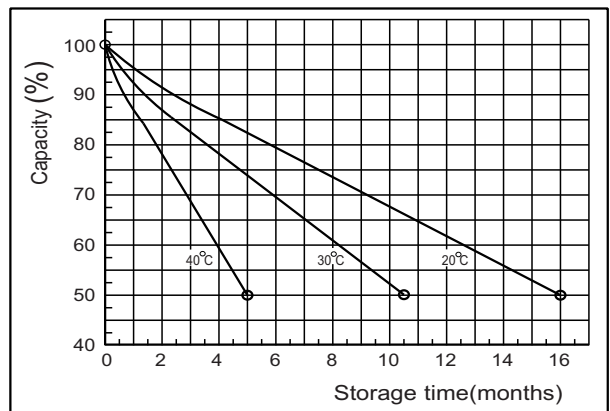

● **Floating life on Temperature**

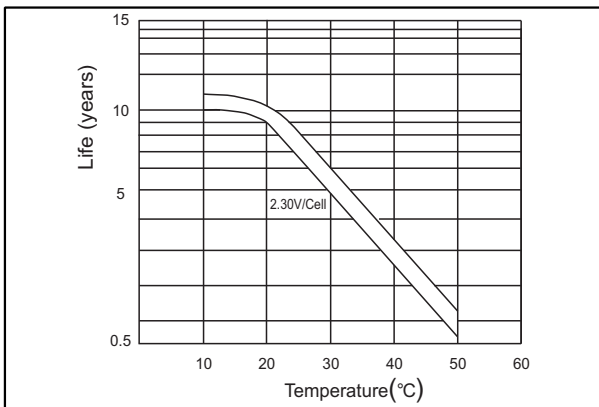

● **Cycle life on D.O.D (25°C)**

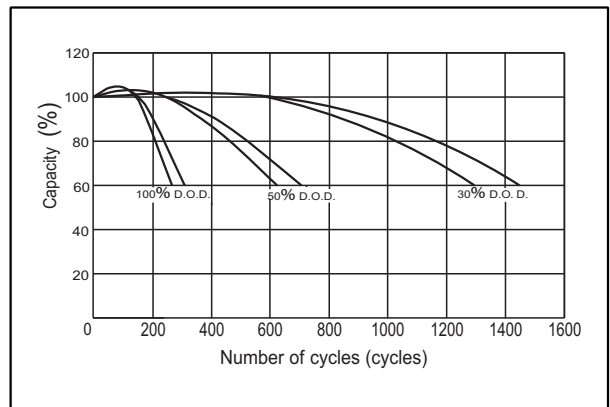

● **The relationship for OCV and Capacity (25°C)**

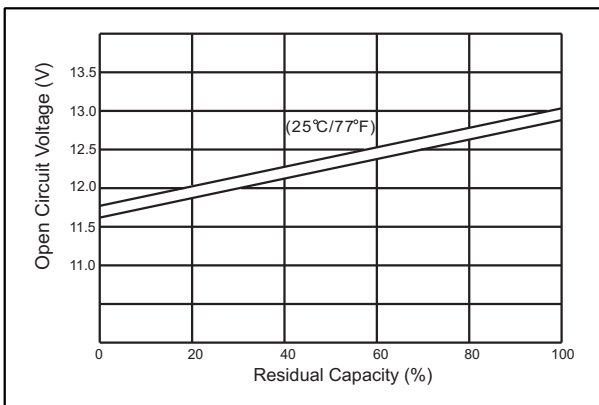

● **The relationship for Charging voltage and Temperature**

